

WORKFORCE PUMP
WORKFORCE™ WWS500 Pump
WORKFORCE PUMP

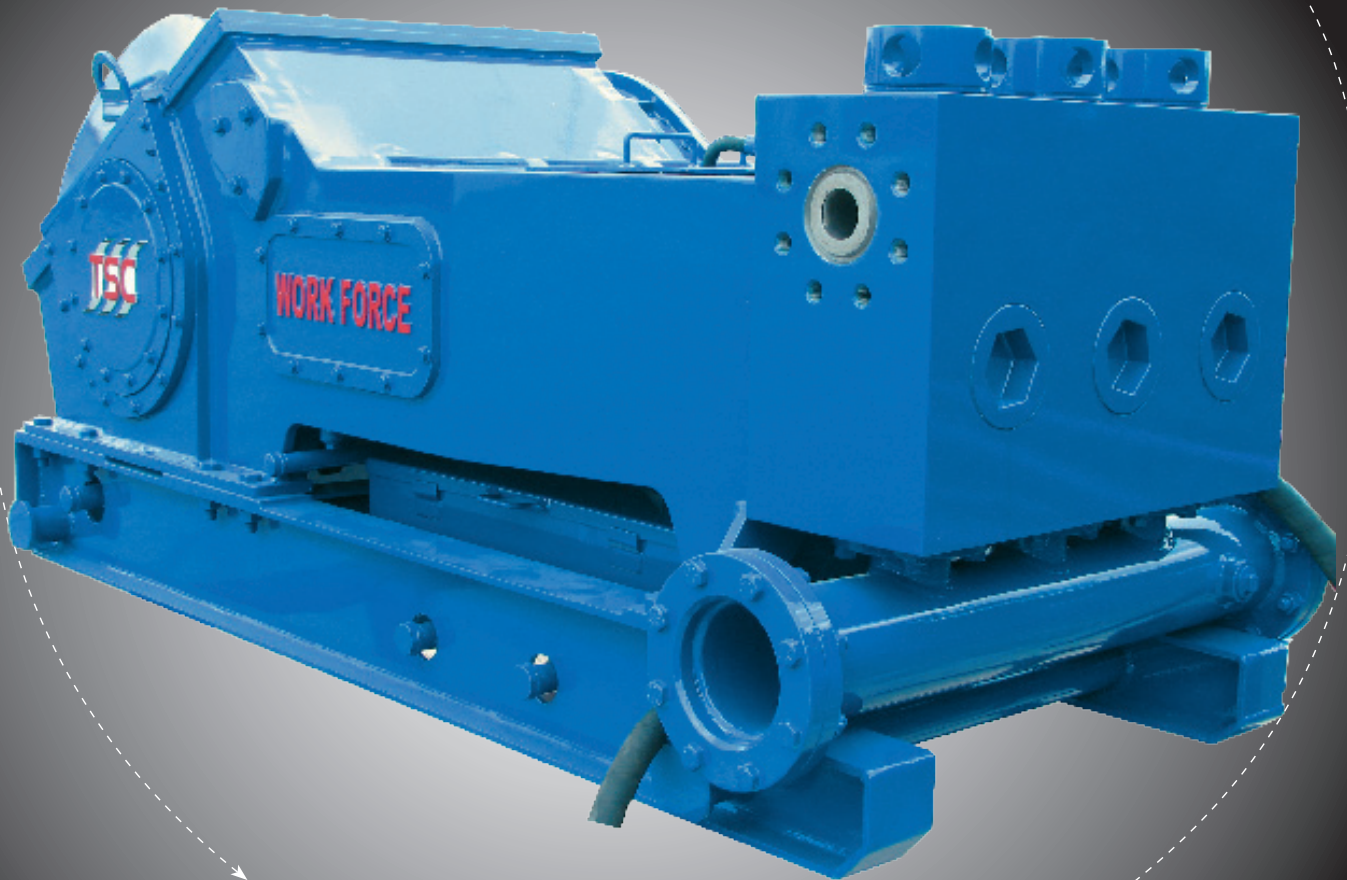

GLOBAL SOLUTIONS

DESIGNING, MANUFACTURING AND PACKAGING FOR THE OFFSHORE INDUSTRY

WORKFORCE™ WWS500



Reinforced, 36 Kip high strength, stress relieved, alloy-steel **Pump Frame** provides rigidity where its needed and longevity where its wanted. Heat treatment after fabrication removes residual stress and prevents distortion after final machining.

Forged, welded and heat treated low alloy steel **Connecting Rods** provide optimal operation integrity under continuous load. Fewer welds allow for enhanced durability.

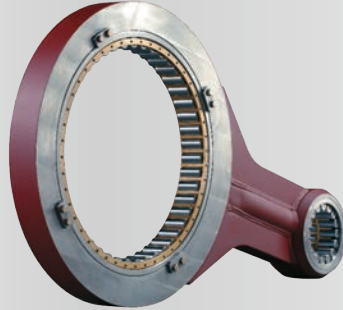

Super Bolt & Nut on Main Bearing cap provide significantly higher yield and tensile strength than the standard hex nut and eliminate the need for special tools not commonly available on drilling rigs.

Premium SKF, Timken or equivalent **Bearings** with minimum L10 life of 30,000 hours at rated load.



Ultra compact, lightweight, harmonically balanced and aligned ground up innovative **Design** results in quiet, low vibration performance, lower operating and transport costs, and industry leading power to weight ratio.



Forged and heat treated, high strength alloy steel ANSI 4340, double helix **Gear** machined to **AGMA 10** & provide longer service life and stronger resistance against chipping under continuous load.



Forged **Pinion** shaft with machined gear made from high strength **ANSI 4340** steel forging for enhanced rigidity and service life.

One piece forged, balanced, and heat treated alloy Steel **Crankshaft** delivers maximum service life. Bolted components allow for easy repairs and optimal sustainability.



Interchangeable with OEM fluid end modules & components for savings in stocking inventory.



Why Choose WORKFORCE™?

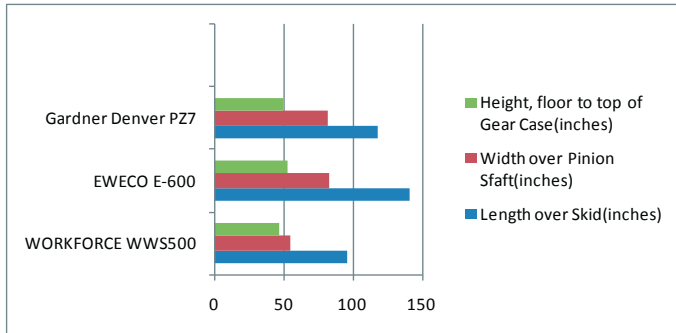

Smaller Footprint, More Horsepower

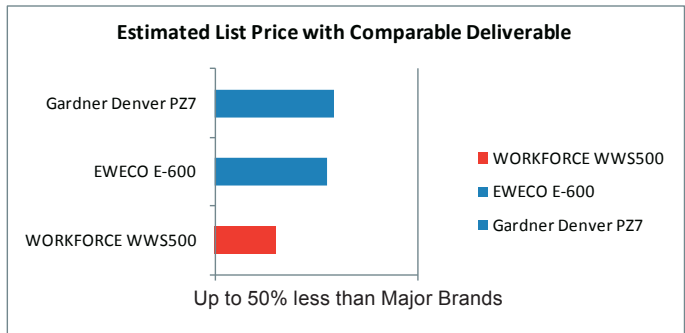

Lower Cost, Better Value

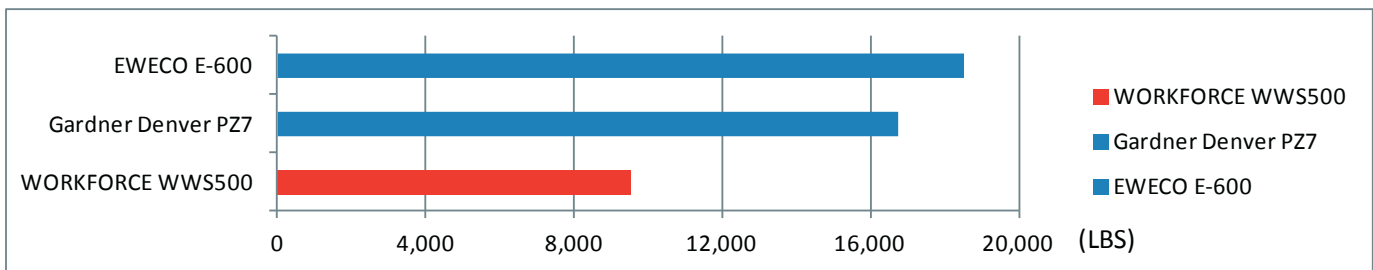

Lighter Weight. More Robust

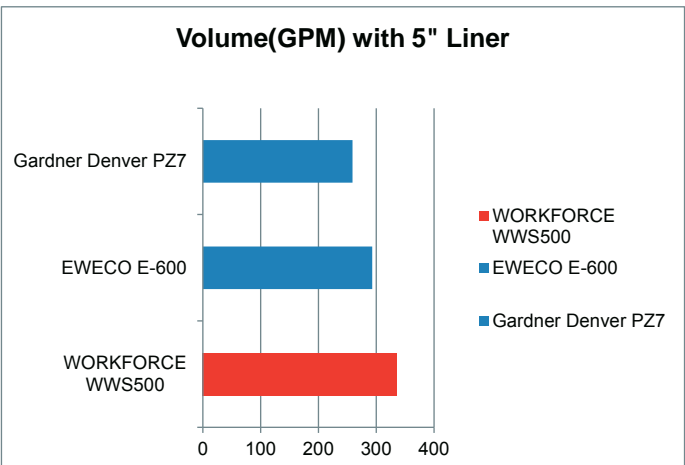
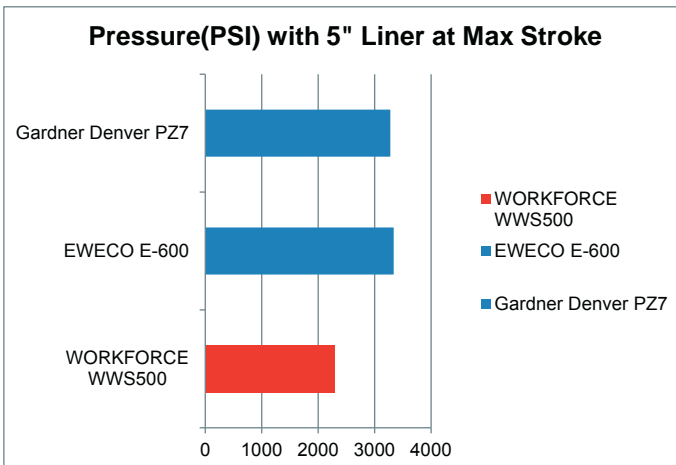

Balanced Performance, Longer Life

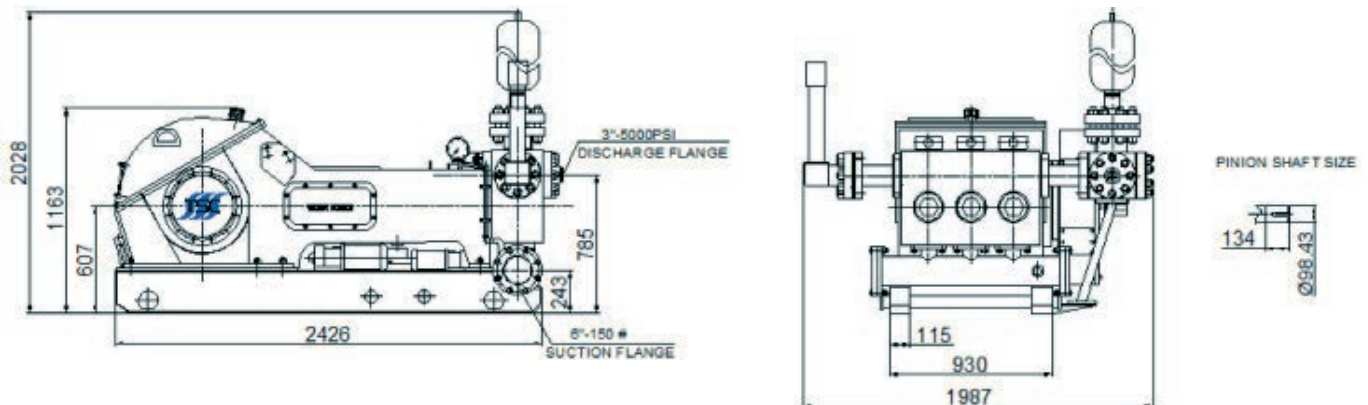

Specifications

Nominal Input Power:	500 HP (373 kW)
Maximum Continuous Pinion Torque:	2,972 lb-ft
Maximum Strokes per Minute:	155
Stroke length:	8.5 inches (215.9 mm)
Gear Ratio:	5.7 : 1
Maximum Piston Diameter & Pressure:	5 inches (127 mm) @ 2,296 PSI
Minimum Piston Diameter & Pressure:	3 inches (76.2 mm) @ 5,000 PSI *
Suction Manifold:	6 inch with 150 pound flanges
Discharge Manifold:	3 inch with API 5,000 PSI flanges
Oil Capacity:	55 gallons (208 liters)
Pump Dry weight (including skid):	9,500 lbs (4,300 kg)

* Pressure rating limited to fluid end module and discharge flange ratings

Performance Characteristics

WWS500 Performance Characteristics		Pinion HP	97	161	226	290	355	419	500	
			Pinion lb-ft	2,972						
			Pinion RPM	171	285	399	513	627	741	884
Piston Dia	Pressure	Strokes/min	30	50	70	90	110	130	155	
3"	5,000 psi	GPM	23	39	55	70	86	101	121	
3.5"	4,685 psi		32	53	74	96	117	138	165	
4"	3,587 psi		42	69	97	125	153	180	215	
4.5"	2,834 psi		53	88	123	158	193	228	272	
5"	2,296 psi		65	108	152	195	238	282	336	

Notes:

- All data subject to change without notice
- All data is based on 100% or continuous duty cycle
- Data is based on 90% mechanical and 100% volumetric efficiency
- Achievable pressure will be limited by input power and fluid end module pressure limitations

Standard Features:

- Compact footprint with high horsepower to weight ratio
- Rigid, fabricated oilfield style frame and skid providing a stable platform for pump operation
- Bearings designed for minimum L10 life of 25,000 hours
- Cast cross heads and guides to maximize longevity
- Fabricated crank shaft with forged core to minimize vibration and insure longevity
- High strength steel used in all drive components
- Alloy steel, monoblock fluid end module with API standard valves and seats and components interchangeable with PAH style
- Electrical lube and liner wash pump assemblies

Options:

- Discharge strainer cross assembly
- 5 gallon pulsation dampener
- Pressure relief valve
- Discharge pressure gauge
- Centrifugal charge pump assembly
- Hydraulic seat puller
- Mechanical lubrication and liner wash assembly
- Custom unitized package with diesel or electric (AC or DC) drive system



WORKFORCE™ MAKE THE DIFFERENCE

WORK FORCE™

- ✓ **Innovative Design** - Compact, lightweight, harmonically balanced and aligned
- ✓ **Frame** - Robust, double reinforced 50 Kip high strength, heat treated, stress relieved low alloy steel, designed for discharge pressure up to 7500psi
- ✓ **Crankshaft** - Forged and heat-treated alloy steel, balanced, mounted to the power frame with double-row, self-aligning radial spherical roller bearings
- ✓ **Connecting Rod** - Low alloy steel, forge-welded and heat-treated
- ✓ **Bull Gear** - Forged and heat-treated, alloy steel ANSI 4340, double helix gear machined to AGMA grade 10
- ✓ **Pinion Shaft** - Forged and heat-treated, alloy steel ANSI 4340, double helix gear machined to AGMA grade 10, teeth surface hardened to BHN 360-400
- ✓ **Bearing** - Premium SKF, Timken or equivalent bearings typically with minimum L10 life of 30,000 hours at rated load
- ✓ **Crosshead** - Nodular ductile, cast iron with interchangeable slides
- ✓ **Super Nut** - on Main Bearing cap in lieu of Hex nuts
- ✓ **Lube System** - AC Electrical system standard
- ✓ **Fluid End Modules** - Interchangeable with Multiple OEM fluid end modules & components
- ✓ **Rubber Sealing Components** - American rubber components standard

Common Generic Brands

- **Design** - Generally copied from antiquated designs. Functional, but are generally characterized to be unbalanced, heavy, large and comparatively lower power to weight ratio
- **Frame** - Uses a 32 Kip welded steel plating capable of handling discharge pressure to 5000psi on the power frame
- **Crankshaft** - Cast Alloy steel single or multi piece core with welded components
- **Connecting Rod** - Cast, 3 piece welded steel Connecting Rods
- **Bull Gear** - Gear from ANSI 4140 steel, forged, machined to AGMA grade 8, teeth surface hardened to BHN 270-300
- **Pinion Shaft** - Forged Pinion shaft, gear machined to AGMA 8, teeth surface hardened to BHN 320-350
- **Bearing** - Chinese made bearings with L10 life of or less 15,000 hours under rated load
- **Crosshead** - slides are not interchangeable
- **Chinese made hex nut** with generally inconsistent yield strength
- **Generly used Lube system** - not offered as standard
- **Fluid End Modules** - Interchangeable with only single OEM counterpart
- **Rubber Sealing Components** - Chinese made rubber components standard



WORKFORCE™ Triplex Pump

- Localized Service through a Global Network
- Maintenance/Repair Service
- Alignment, Clearance & Tolerance Adjustments
- Internal Repair/Replacement Service
- Closed Circuit Pressure Testing
- Unitized Pump Packages with Diesel or Electric Drive
- Complete Pump Refurbishment
- 24x7x365 Technical Support

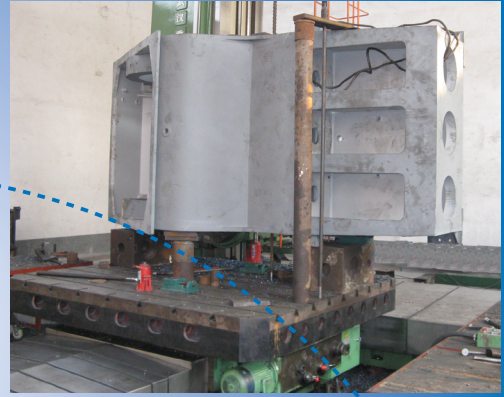
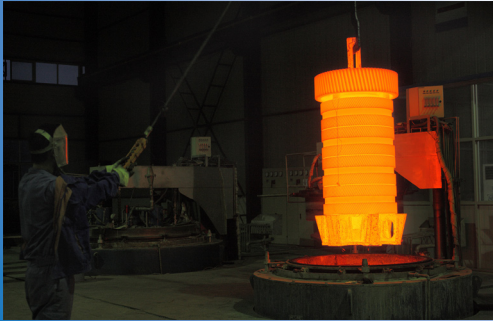

- API 7K, Q1 & ISO 9001 Certified
- World Class R&D Team
- Fully Stocked Local Inventories
- Wholly-owned Manufacturing Facilities
- Global Quality System

- Worldwide Immediate Parts Support
- Mature Global Supply Network
- Available Maintenance Agreements
- Rental Services
- In House Financing Available on Volume Orders

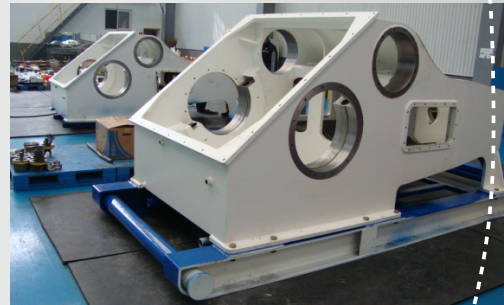

TSC Manufacturing and Supply LLC, 13788 West Road, Suite 100, Houston, Texas 77041, USA
Tel: +1 832 456 3900 Fax: +1 832 456 3998 Email: sales@t-s-c.com
Visit our Website at www.t-s-c.com